

INSTALLATION MANUAL



BOND / CLASSIC / TUDOR / SHAKE

These installation details are provided to demonstrate the recommended installation methods for Tilcor products and accessories.

Consult with Tilcor Roofing Systems for additional information.



Metals[™]
ROOFING SYSTEMS



IKO Metals Europe NV
Tilcor Roofing Systems
Phone: (+32) 12 24 18 01
Email: info@tilcor.com

Michielenweg 3, 3700 Tongeren, Belgium

www.tilcor.eu

1. General Information	4
2. Recommended Tools	8
3. Profile and Flashing Specifications	10
4. Preparation of The Roof Surface for Installation	15
5. Tile (BOND, CLASSIC, TUDOR) Installation	17
6. Tile Installation (SHAKE)	20
7. Eaves Flashing	21
8. Box Barge Installation (BOND, CLASSIC, TUDOR, SHAKE)	22
9. Installation of Barrels at The Ridge and Hip	23
10. Roof Window Installation	24
11. Roof Ventilation, Extractor and Sanitary Vents	25
12. Valley Installation	26
13. Side Wall Flashing	28
14. Chimney Flashing	29
15. Mansard Roof Including a Change of Roof Pitch	30
16. Re-roofing	30

1. GENERAL INFORMATION

1.0 Description.

- 1.1. IKO Metals Europe leads the world in steel roof tile production and technology. Recognition of market needs has driven the company's success. Roofs produced by IKO Metals Europe have protected many thousands of homes and commercial buildings around the world since 1957.

Tilcor Shake, Tudor, Bond and Classic Tiles form the basis of an evergrowing range of profiles that are in regular demand across Europe and throughout the rest of the World. Our company's vision is to provide innovative high quality roofing systems that everyone aspires to have on their home. Our company's core values include a willingness to meet all challenges, to conduct our affairs with honesty and integrity and, very importantly, to provide our customers with genuine value for money.

IKO Metals Europe is a subsidiary of IKO Group, a company with a world wide reputation in the building materials sector. Our staff at IKO Metals Europe is committed to working with you to achieve the home of your dreams.

2.0 Materials

- 2.1. Aluminium-Zinc consists of steel hot-dip coated with an aluminium/zinc alloy complying with EN 14782:2006 / EN 508 / EN 10346.

The steel is S280GD (Structural Drawing) grade 0.4 mm thick. To the topside of the Aluminium-Zinc coated steel formed profile, one of the following coating systems is applied:
 Textured Coating - an acrylic base-coat which binds a layer of stone granules covered with an acrylic overglaze

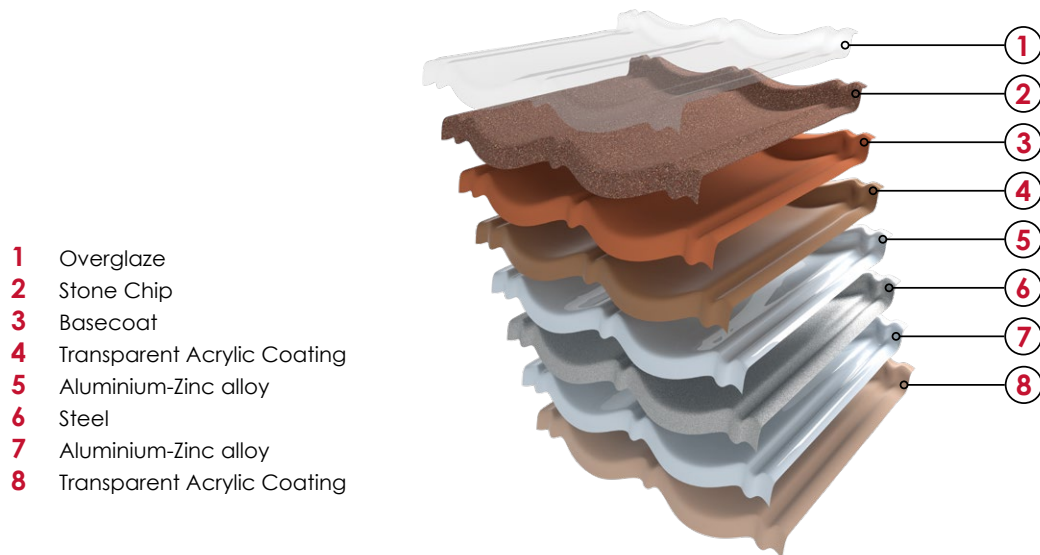

3.0 Colours

- 3.1 Tudor is supplied in the following colours:
- Textured - Charcoal, Slate, Brown Bark, Cedar, Autumn, Coffee Brown, Green, Terracotta.
- 3.2 Shake is supplied in the following colours:
- Textured - Charcoal, Brown Bark, Autumn, Coffee Brown, Cedar, Green.
- 3.3 Bond is supplied in the following colours:
- Textured - Charcoal, Brown Bark, Autumn, Coffee Brown, Green, Terracotta
- 3.4 Classic is supplied in the following colours:
- Textured - Charcoal, Slate, Brown Bark, Autumn, Coffee Brown, Green, Terracotta

4.0 Packing

- 4.1. The tiles are packed on wooden pallets protected with temporary waterproof covering for delivery to the site.
- 4.2 Flashings, V - Ridge, Barrel Trim and other accessories are packed separately.

5.0 Handling and Storage

- 5.1 The product must be transported and handled with care to avoid damaging the surfaces.
- 5.2 Long-term storage of roofing must be under dry, ventilated cover.
- 5.3 For short-term storage on site, pallets should be placed separately on level ground.
- 5.4 The products must be left covered with the waterproof covering on, when stored short-term on site in order to avoid water stains.

6.0 General Installation Information

- 6.1 Tilcor Roofing Systems must be installed in accordance with the manufacturer's instructions as contained in this document.
- 6.2 Care must be taken when handling, cutting, bending, and installing the roofing in order to avoid damage to the surface. In particular, the roofing surface must be kept clean of dirt and other substances such as metal swarf.
- 6.3 Flat, rubber-soled shoes must be used when working on the roof, and protective padding used on tools. Loads must be applied only over battens and the installed roofing protected from other construction and finishing work being carried out on or above the roofing, such as cladding materials, plaster and paint.

7.0 Roof Framing

- 7.1 Roof framing should provide support and fixing for the tile battens that will satisfy the design load wind requirements.
- 7.2 Installers should check that the framing has been erected to an accurate and even line before roof fixing is started.
- 7.3 An inspection and any rectification to the framing alignment must be carried out before roof fixing is commenced.

8.0 Tiling Battens

- 8.1 Battens must be treated, sized, and fixed according to local regulations. On new roofing underlay, e.g. as given in Acceptable Solution E2AS1 Paragraph 1.3, must be fixed in place first in accordance with the instructions of the underlay manufacturer.

9.0 Special Flashings

Special flashings are made as required by the manufacturer from uncoated steel and subsequently factory coated using the same coating process as used for tiles or alternatively manufactured on site by the roofer using factory finished tiles and accessories and cutting and bending to the desired shape.

10.0 Durability

- 10.1 Tilcor warrants that each roofing tile comprised in the roof fitted to the purchaser's property, will carry an appropriate weatherproof warranty. This warranty does not cover damage due to improper handling, installation or damage occurring after installation. Please refer to Country Warranty for further information.
- 10.2 Installation must be in accordance with instructions of Tilcor Roofing Systems Ltd.
- 10.3 Where the roof space is not completely closed-off to the elements, the underside of the roof must be completely shielded with roofing underlay or sheathing such as fibre cement, hardboard or plywood.

Limitations on use

- 10.5 Tilcor Roofing Systems must not be used in high alkaline environments, (such as on intensive animal shelters or other buildings with high ammonia or urea concentrations), and/or contact with fresh concrete or plaster must be avoided.
- 10.6 The roofing must not be used in contact with permanently damp materials, on industrial buildings in which corrosive processes occur, or over swimming pools.
- 10.7 Copper in any form must not be allowed to contact the roofing, and care must be taken to ensure that runoff from copper overflow or down pipes does not come into contact with the tiles.
- 10.8 Lead or lead edged flashings must not be used with Tilcor Roofing Systems unless a suitable barrier paint system is applied to both surfaces to ensure there is no metal to metal contact, or contact through water runoff. The manufacturer supplies flashings that are suitable for use with the roofing products.

Weathering

- 10.9 With granule-coated products, some loss of granules and overglaze can be expected over time.

Maintenance

- 10.11 Tilcor pressed metal roofing tiles require minor maintenance to ensure the continued performance of the roof over its life.
- 10.12 Where possible a visual ground inspection of your roof should be performed every year, or after any significant storm, for the following items. Maintenance or repairs to these items should help prevent any major problems occurring:
 - Damaged or displaced tiles or flashings.
 - Blocked valleys, spouting or downpipes with debris such as leaves, other plant matter or foreign objects such as toys.
 - Wash down any roof areas not effected by rain washing (see Cleaning below).
- 10.13 In certain environmental conditions moss, mould or lichen may present itself on areas of the roof. To maintain the integrity of the coating and for aesthetic reasons this can easily be removed with a generic roof wash treatment, such as Roof Guard, applied by low pressure spraying. When the roof is used for collection of potable water, ensure that the downpipes are disconnected for the period stated in the spraying instructions. Failure to maintain the roof in this manner will void the coating warranty.
- 10.14 When repairs or maintenance are needed we recommend that you consult a metal tile roofing specialist, as additional damage to the roof tiles can be caused by inexperienced foot traffic (If you must access the roof follow these instructions, to avoid denting or damaging the roof tiles, you should wear soft sole shoes & place your foot on the lowest point of the tile and at the front edge of the tile). Also, house holders unfamiliar with working at height pose considerable risk of injury to themselves by falling from ladders or the roof.

Cleaning

- 10.15 Tilcor roofs must be washed down regularly with fresh water in all areas not washed by rain, such as those areas sheltered by the eaves overhang of a higher roof. In areas near the sea, where salt deposition is noticeable on windows and similar surfaces, or near areas of industrial pollution, washing down should be carried out every 2-3 months. In other areas, washing down every 6 months should suffice.
- 10.16 Lichen and mould growth must be removed with chemical cleaners recommended by IKO Metals Europe, such as Roofguard Cleaner. Tilcor recommends to chemically clean the roof once every 2-4 years to maintain a good appearance and prevent the growth of algae, moss and lichen. Failure to carry out this maintenance program will void the coating warranty (see Tilcor coating Warranty).



Figure 2.

11.0 Dissimilar Metals

- 11.1 To avoid adverse corrosion effects caused by dissimilar metals, COPPER and LEAD flashings should not be used with Tilcor roofing products and accessories. Under no circumstance should these materials be in contact or allow water runoff from these materials to flow on to the roof. Failure to comply with this will void the weatherproof warranty.

12.0 Touch-Up Kit

- 12.1 Minor scuffing of the tiles can be repaired with the Touch-Up kit from Tilcor. Use the Acrylic Touch-Up kit from Tilcor (not sealants). Coloured aerosol paints should never be sprayed on tiles or accessories made by Tilcor.



2. RECOMMENDED TOOLS

Tilcor Roofing Systems are installed with standard construction tools. The tiles may be cut with tinsnips, or Guillotine (cutter) supplied as part of the Tilcor installation kit that consists of: 1 Guillotine (cutter), 1 Bender, 1 Top Course Bender.

Guillotine (also known as Cutter)

Weight: 30 kg



Combined tile bender

Weight: 60 kg



2. RECOMMENDED TOOLS

Impact or Screw Gun



Hand Bender



Hammer

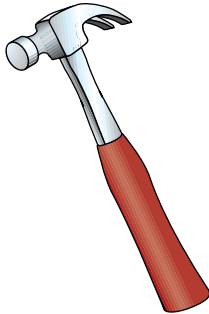

Measuring Tape



Nail Gun



Tin Snips



Set-out Rod



Bevel

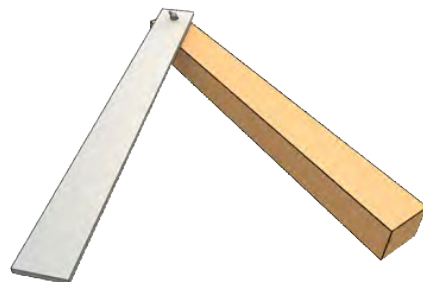

3. PROFILE AND FLASHING SPECIFICATIONS

CLASSIC TILE



Specifications

Overall Length	1320 mm
Length of Cover	1265 mm
Overall Width	415 mm
Width of Cover	369 mm
Roof Cover	0.467 m ²
Minimum Pitch	12° (21%)
Tiles per m ²	2.14
Weight/panel	2.90 kg
Weight/area	6.56 kg/m ²
Batten space	369 mm

Colour range

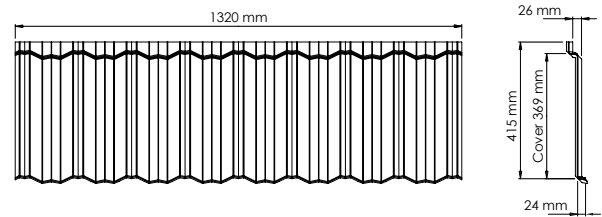

BOND TILE



Specifications

Overall Length	1330 mm
Length of Cover	1270 mm
Overall Width	415 mm
Width of Cover	371 mm
Minimum Pitch	12° (21%)
Roof Cover	0.469 m ²
Tiles per m ²	2.13
Weight/panel	3.01 kg
Weight/area	6.41 kg/m ²
Batten space	371 mm

Colour range

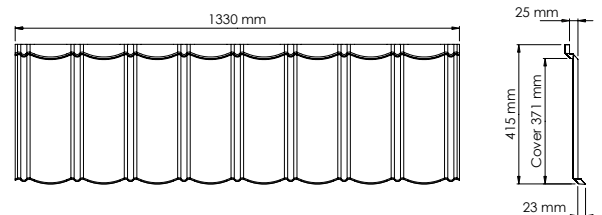
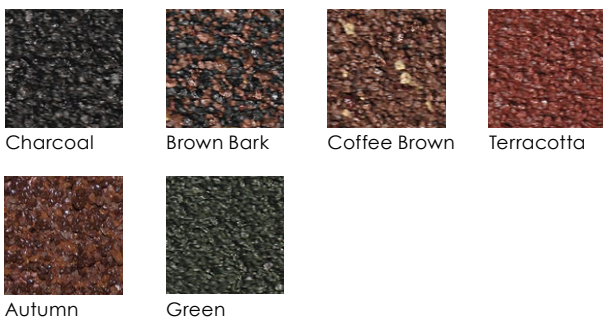

3. PROFILE AND FLASHING SPECIFICATIONS

TUDOR TILE



Specifications

Overall Length	1305 mm
Length of Cover	1240 mm
Overall Width	415 mm
Width of Cover	367 mm
Minimum Pitch	12° (21%)
Roof Cover	0.459 m ²
Tiles per m ²	2.18
Weight/panel	3.00 kg
Weight/area	6.54 kg/m ²
Batten space	367 mm

Colour range

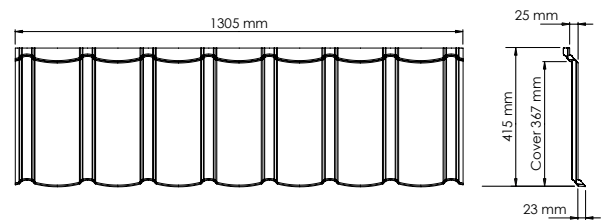

SHAKE TILE



Specifications

Overall Length	1340 mm
Length of Cover	1262 mm
Overall Width	415 mm
Width of Cover	369 mm
Minimum Pitch	15° (27%)
Rroof Cover	0.47 m ²
Tiles per m ²	2.15
Weight/panel	3.10 kg
Weight/area	6.66 kg/m ²
Batten space	369 mm

Colour range

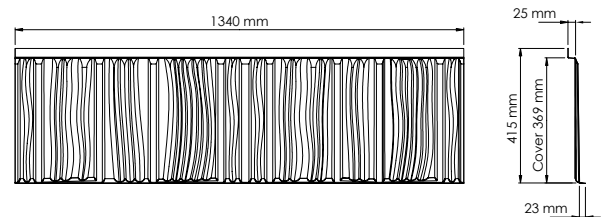
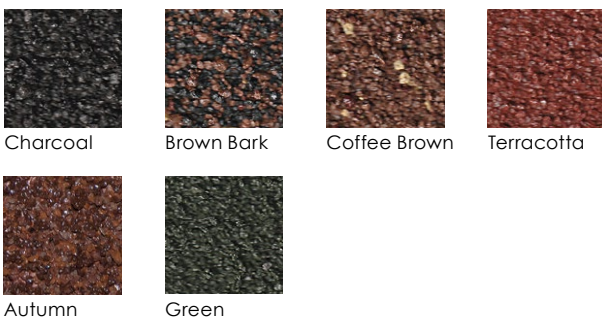

3. PROFILE AND FLASHING SPECIFICATIONS

Ridge Barrel 205



Specifications
 Length: 423 mm
 Length of Cover: 400 mm
 Weight: 0.75 kg
 Colours: see colour chart

Ridge Barrel End 205



Specifications
 Diameter: 190 mm
 Weight: 0.15 kg
 Colours: see colour chart

Y-Hip Ridge Barrel 205 15°-30°



Specifications
 Colours: see colour chart

Y-Hip Ridge Barrel 205 30°-45°



Specifications
 Colours: see colour chart

Ridge Barrel Moulded End 205



Specifications
 Length: 455 mm
 Weight: 0.85 kg
 Colours: see colour chart

Angle Ridge



Specifications
 Length: 425 mm
 Length of Cover: 380 mm
 Weight: 0.51 kg
 Colours: see colour chart

Angle Ridge End



Specifications
 Length: 165 mm
 Weight: 0.09 kg
 Colours: see colour chart

Angle Ridge Moulded End



Specifications
 Weight: 0.10 kg
 Colours: see colour chart

Y-Hip Angle Ridge 15°-30°



Specifications
 Colours: see colour chart

Y-Hip Angle Ridge 30°-45°



Specifications
 Colours: see colour chart

Eaves Flashing



Specifications
 Length: 2000 mm
 Length of Cover: 1900 mm
 Weight: 1.10 kg
 Colours: see colour chart

Box Barge



Specifications
 Length: 2000 mm
 Length of Cover: 1900 mm
 Weight: 1.60 kg
 Colours: see colour chart

3. PROFILE AND FLASHING SPECIFICATIONS CONTINUED

Box Barge Scribed Univ. 140 Left



Specifications
 Length: 1250 mm
 Length of Cover: 1100 mm
 Weight: 1.50 kg
 Colours: see colour chart

Box Barge Scribed Univ. 140 Right



Specifications
 Length: 1250 mm
 Length of Cover: 1100 mm
 Weight: 1.50 kg
 Colours: see colour chart

Side Wall Flashing Scribed Left



Specifications
 Length: 1250 mm
 Length of Cover: 1100 mm
 Weight: 1.50 kg
 Colours: see colour chart

Side Wall Flashing Scribed Right



Specifications
 Length: 1250 mm
 Length of Cover: 1100 mm
 Weight: 1.50 kg
 Colours: see colour chart

Side Wall Flashing



Specifications
 Length: 2000 mm
 Length of Cover: 1900 mm
 Weight: 1.64 kg
 Colours: see colour chart

Ridge Cover 130



Specifications
 Length: 1335 mm
 Length of Cover: 1250 mm
 Weight: 2.11 kg
 Colours: see colour chart

Square Ridge



Specifications
 Length: 1355 mm
 Length of Cover: 1250 mm
 Weight: 1.20 kg
 Colours: see colour chart

Flat Sheet 500/1345



Specifications
 Dimensions: 1345 mm x 500 mm
 Weight: 3.05 kg
 Colours: see colour chart

Valley SC



Specifications
 Overall Length: 1350 mm
 Length of Cover: 1250 mm
 Weight: 1.8 kg
 Colours: Black, Red

Vent Adapter



Specifications
 Connection: R150/130/125/110/100 mm

Sanitary Vent HV15-15



Specifications
 Weight: max. 1.95 kg
 Available also for Classic, Tudor and Shake
 Colours: see colour chart

Sanitary Vent HV110



Specifications
 Weight: max. 1.25 kg
 Available also for Classic, Tudor and Shake
 Colours: see colour chart

3. PROFILE AND FLASHING SPECIFICATIONS CONTINUED

Vent LV75



Specifications

Weight: max. 1.15 kg
Available also for Classic, Tudor and Shake
Colours: see colour chart

Tube Tile 1 Pipe



Specifications

Weight: max. 1 kg
Available also for Classic, Tudor and Shake
Colours: see colour chart

Tube Tile 2 Pipes



Specifications

Weight: max. 1 kg
Available also for Classic, Tudor and Shake
Colours: see colour chart

Solar Holder 2G

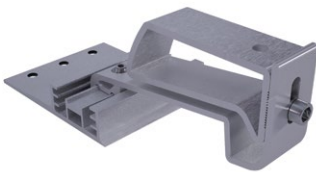

Specifications

Material: High-grade Aluminium
Weight: 0.9 kg
3 adjustable heights: 40 mm, 47 mm, 54 mm

Repair Kit



Specifications

Colours: see colour chart

Roof Guard



Specifications

Net Weight: 5.5 kg

Nails 50 × 2.8 Galvanized



Specifications

Package: 5 kg/box
Colours: Black, Red

Fasteners 5 × 35 mm



Specifications

TORX® ttap
Dimensions: 5 × 35 mm
Package: 500 pcs./box
Colours: Black, Red

Fasteners 5 × 50 MM



Specifications

TORX® ttap
Dimensions: 5 × 50 mm
Package: 300 pcs./box
Colours: Black, Red

4. PREPARATION OF THE ROOF SURFACE FOR INSTALLATION

1. BATTEN SPACING.

The most critical factor in preparing the roof structure accurately is setting out the tile battens. If the task is not performed exactly according to the instruction, stone-coated roofing panels cannot be fixed properly. We recommend and present using tile battens with dimensions 50x40 mm as the most popular battens. They may be replaced with 50x25 mm and 50x50 mm battens if the spacing and dimensions of rafters are different from the standard 70-100 cm.

The first 50x40 mm batten is placed directly at the lower edge of the roof. This will serve as an eave batten. The next batten is placed approx. 320 mm above the eave batten as measured from the lower edge of the eave batten to the lower edge of another batten. Further battens are placed at a distance specific for the used profile, measured from the lower edge of the first batten to the lower edge of the upper batten. Fig. 4.

We recommend preparing a special setout rod to mark the positions of battens faster and easier.

At notches in the rod set out every batten spacing for profile to be used, nails are placed in every notch to mark the positions of battens.

If distances between battens are not correctly measured, this will cause the roof to be exposed to wind and make it impossible to fix the panels evenly. It is important then to make measurements of battens with high accuracy.

If possible, pay special attention to selecting rafters of the right length so that they match the total number of tile panels. This will help avoid material losses and minimize non-recyclable waste. If this is impossible, cut the upper row of panels appropriately.

2. CUTTING BATTENS AND COUNTER-BATTENS.

It should be remembered that battens are to be joined only on rafters. Care should be taken not to have multiple joints of battens close to one another in the immediate vicinity. This would weaken the structure of the roof.

Counter battens are used for vented roofs to allow for air circulation from the eaves to the ridge. They are also used to facilitate transmission of vapor and condensate that may appear under the covering. Counter-battens are fixed along rafters with nails. Fig. 3.



Figure 3.

Name of the profile	Batten Spacing (x)
CLASSIC TILE	369 mm
BOND TILE	371 mm
TUDOR TILE	367 mm
SHAKE TILE	369 mm

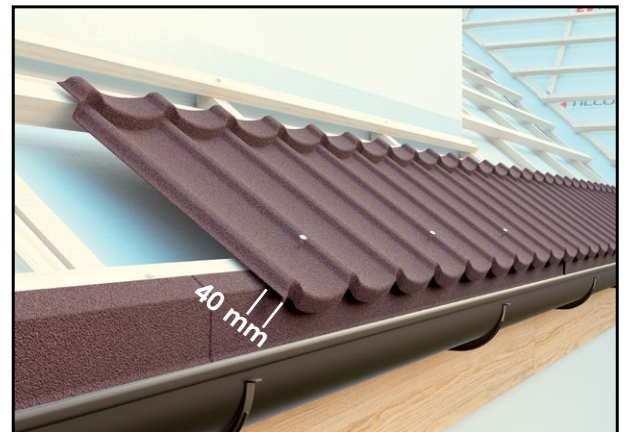

Figure 4.



Figure 5.

4. PREPARATION OF THE ROOF SURFACE FOR INSTALLATION

3. Fixing roof underlays.

Having measured and cut the battens to the right length, we take them off and start fixing roof underlay. We recommend using roof underlays of high vapor permeability available on the market. They will ensure appropriate ventilation of the roof surface.

The underlay is to be fixed starting from the eaves and rolled out horizontally. It should be remembered that the lower edge of the roof underlay should overhang approx. 40-50 mm below the roof edge – the fascia board.

The underlay is fixed gradually, moving from the eaves to the ridge. Overlaps should be not smaller than 100-150 mm unless two underlay sheets are joined directly under a batten. Then, overlaps of approx. 75 mm may be used. Roof underlay is fixed with staples.

At the ridge and a valley, two layers of roof underlay should be fixed. We also recommend that the underlay is put up to approx. 100-150 mm over a facade or chimney in the roof.

4. Fixing battens and counter-battens.

Counter-battens, most often 25-50 mm or wider up to 50-80 mm, are fixed along the rafters. They will ensure ventilation space between the roof underlay and the roof covering with stone-coated tiles. The height of the ventilation space equals the width of a counter-batten. Furthermore, a counter-batten strengthens the fixing of roof underlay. If roof underlay is fixed on full boarding, please use a underlay suitable for this purpose. Counter-battens in this case will be nailed every 60-70 cm. Fig. 6. The battens should be fixed with nails to the rafters. The dimensions appropriate for the system are from 90 x 2.80 mm to 90 x 3.40 mm. If the area is particularly exposed to strong winds, special ring-shank nails.

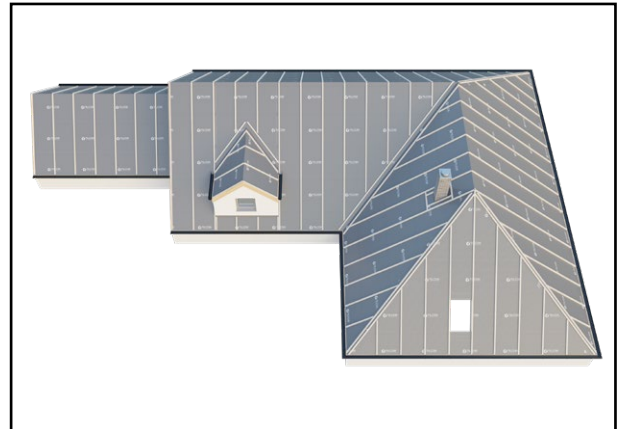

Figure 6.

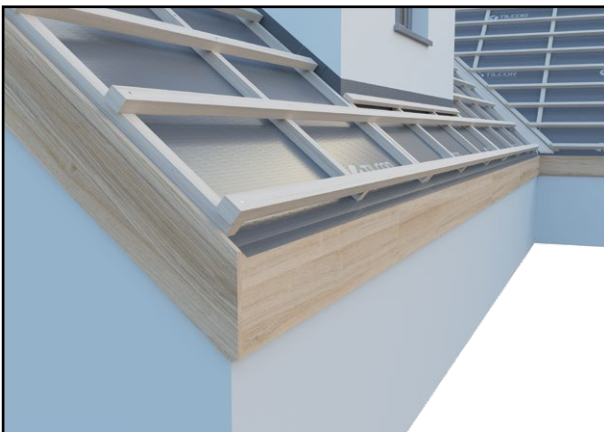

Figure 7.

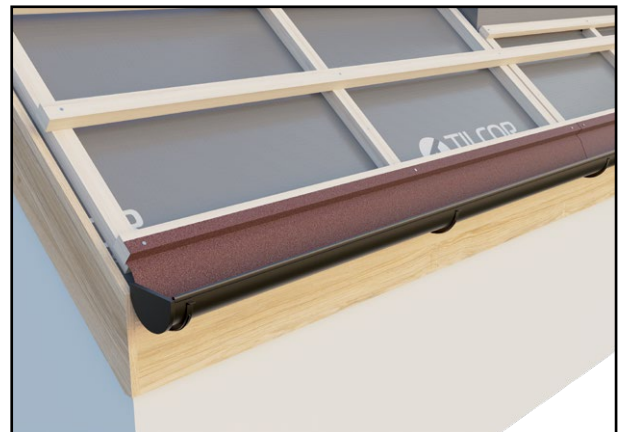

Figure 8.

5. TILE (BOND, CLASSIC, TUDOR) INSTALLATION

During installation, tiles can be interlocked either right over left or left over right. The decision to apply the given type of interlocking is taken by the roofer, who knows where strong winds most often come from or where the access road to the property runs. A skillful application of interlocking improves the esthetic appearance of the roof covering, making it almost impossible to see where panels join each other. The form of interlocking is shown in fig. 9 and 10.

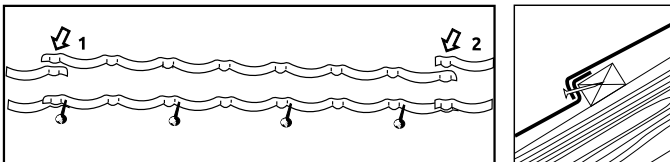

Figure 9.



Figure 10.

Start the installation from the first complete course of panels under the ridge. The course should be left incomplete until the ridge is installed. If there are hips on the roof, the panel is installed so that at least 150 mm is left from the top corner of the tile to the hip. This will make it possible to fix panels in the roof hip easily. Fig. 11.



Positioning of the nail.
4 nails per panel.



Figure 11.

Panels are arranged from left to right or from right to left, being fixed with system nails or a gun nailer. First, the upper panels are installed along the entire course. Then their lower edges are turned up, laying another course below and only then a nail is driven in through the two panels, fixing them firmly.

It should be remembered that tile laps should be staggered across the entire roof covering. This will ensure better appearance and faster installation. Fig. 12.



Figure 12.

5. TILE (BOND, CLASSIC, TUDOR) INSTALLATION

Take care to use each panel maximally effectively. One panel should provide a cut element for a hip and another one to finish off, e.g. a valley.



Figure 13.
Remember to keep the tile laps staggered.
The figures quoted above are given as examples.



Figure 14.

MEASURING AND CUTTING

All the measurements are taken on the roof. We recommend, however, that tile panels should be cut and bent on the ground. To save time for the roofers, we recommend that these actions should be done by two roofers. One will work on the roof, giving the necessary dimensions, while the second will cut and bend the needed elements on the ground.

The right length of a tile is the distance measured from the last lap on a full tile to the roof hip. To measure the cutting angle, put a panel along the hip batten. Add 40 mm for bending panels to the hip batten. Only then, cut the panel.



Figure 15.



Figure 16.



Figure 17.

5. TILE (BOND, CLASSIC, TUDOR) INSTALLATION

Each tile should supply two cut pieces, leaving minimal non-recyclable wastage. In principle, these pieces will be finishing parts of a roof hip and valley but sometimes one panel is used for two roof hips. Fig. 18 and 19..

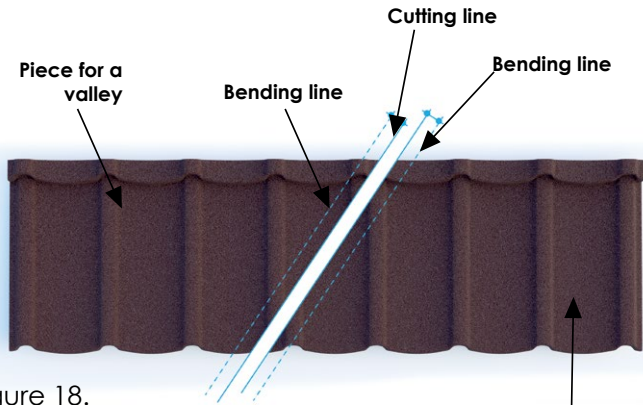

Figure 18.

OR

Bending approx.
40-50 mm for a timber
batten

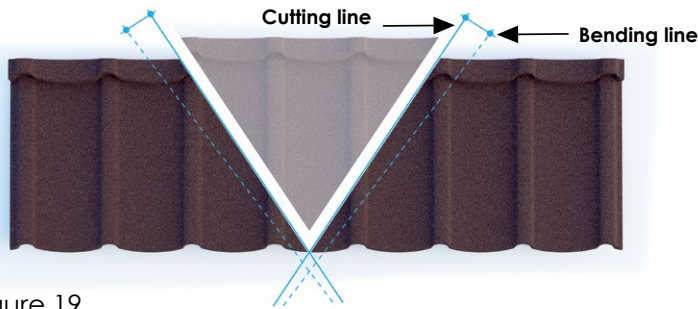

Figure 19.



Figure 20.



Figure 21.

Use a guillotine to cut panels previously marked on the roof. Fig. 20.

To bend panels, use a bender. If you bend many panels, make sure you remember their order so as to avoid installation errors. Take care to hand over the bent panels, directly after bending, to be installed on the roof. Fig. 21.

Installation of cut panels.

Care should be taken to install the top edge of cut panels first. Remember also to fix a bent piece to the hip batten installed on a support. Fig. 22 and 23.



Figure 22.

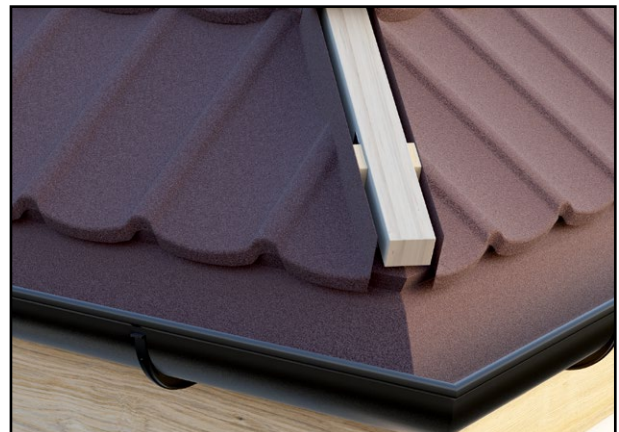

Figure 23.

6. TILE INSTALLATION (SHAKE)

As the Shake profiles have a straight head and nose, the tile laps can be staggered in any way.

1. Using a bevel, mark on the tiles the cutting and bending lines, allowing at least 40 mm fold for the hip batten. To minimize waste, remember to use at most half the tile for each cut so that the other half can be used for a valley cut or another hip cut at the other end of the roof plane. Note: Shake tiles will be turned up a minimum of 40 mm both against the hip batten, and to adjust the tiles under the ridge or bend them against the side wall of a dormer window or a chimney in the roof covering. Use 4 nails per tile to the placement of Tilcor specification.

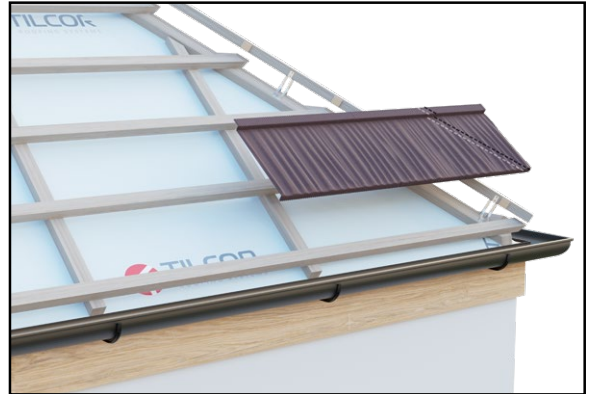

Figure 24.

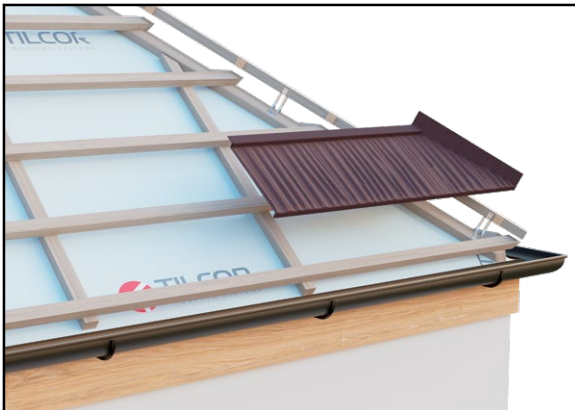

Figure 25.



Figure 26.

2. Install the cut tiles by starting from the top to the bottom of the covering or in special cases the other way round. Remember to fit the panels tightly and fix them esthetically.

3. Install the remaining panels starting from the last full course under the ridge and moving from left to right or from right to left side of the roof.

Arrange the panels, securing them with system nails or a gun nailer to the front edge of the panel (the nose) using 4 nails per one panel.

The last course will be that at the eaves, fixed with 4 nails from above to the eave batten. The nail heads have to be secured with putty and chips in the color of the tiles.

4. Remember to install panels in each lap between them and bent to the ridge or hip battens.

5. When the entire roof covering is fixed, this is the time to start doing the ridge and hips from barrels or long system ridges.

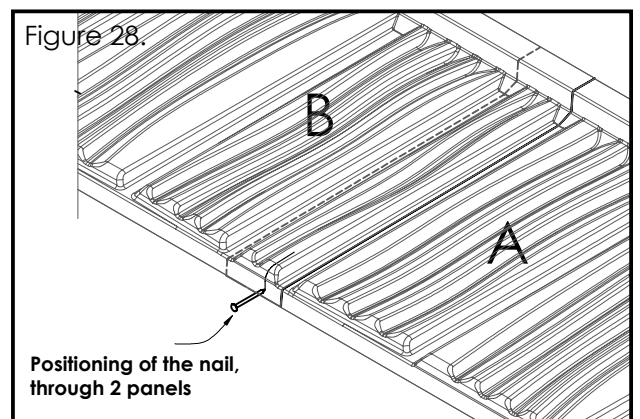
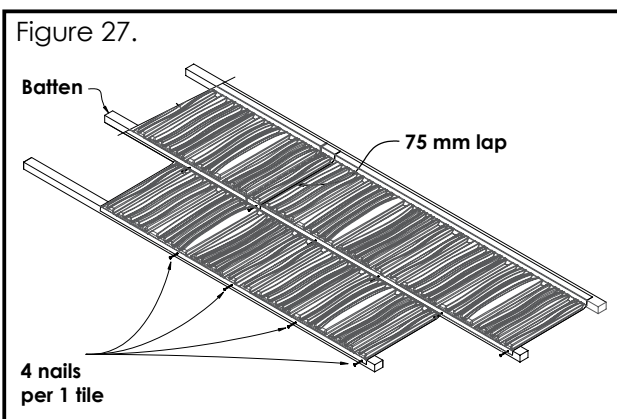

7. EAVES FLASHING

Marking the position of the eaves batten – a solution with a ready-made starting strip.
 Batten fixing starts from marking and nailing the eaves batten which will serve as the reference line to measure one by one the remaining battens up the roof covering. If Tilcor starting system flashing is used, the eaves batten may be used as a gauge. A bend at the back of the starter flashing will show the line of the eaves batten from which the distances of further battens will be measured.



Figure 29.



Figure 30.

It is recommended to apply overlaps of approx. 100 mm on the starter flashing. Remember please that the flashing can be fixed left over right or right over left. The direction of overlaps should be invisible from the main access road to the property where the roof is installed.

If system starting flashing is used, the first course of panels is fixed with system nails to the nose of the tile. Further courses of tiles above are fixed in the same way.

ALTERNATIVE METHOD.

Marking the position of the base batten – a solution without a starting strip of the eaves.
 Nail the front board or batten along the edge of the eaves. Then mark the position of the base batten. The position of the eave batten may be determined using a Tilcor tile as a gauge. The edge of the tile should not overhang the eaves at more than 1/3 of the gutter width. The minimum overhang of the tiles on the bottom row is approx. 40 mm. This will ensure the outflow of water and snow to the gutter avoiding an overflow of water during heavy rains.

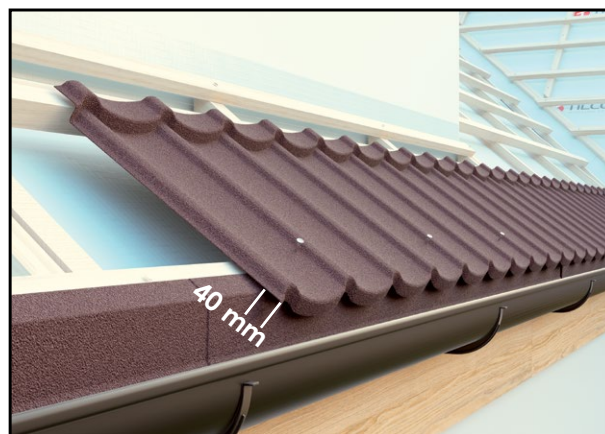

Figure 31.

8. BOX BARGE INSTALLATION

Fix the barge board so that its top edge is not higher than the top edge of the batten. Along batten edges, nail down the barge batten 40x50 mm with dimensions 40x50 mm. The same batten should be used on the covering. This will make it possible to fix in the right way the system barge flashings and panels going to the box barge.

Before the installation of the box barge, it is essential that tiles are turned up against the barge batten. It is important that the box barge is fixed near its lower edge overlapping the barge (gable) board). This will ensure tight fixing and improved appearance. Box barges are installed from bottom up. The finishing of the barge (gable) board may be made with the use of universal standard box barges, profiled box barges and sometimes V Ridges or barrel trims.

This kind of flashings requires that barrels are shaped before adjusting to the box barge to ensure that they are joined tightly. A section of about 30 mm should be straightened so that it adjoins the barge board. Start the installation from the bottom of the eaves line, laying the barrels in perfect alignment.

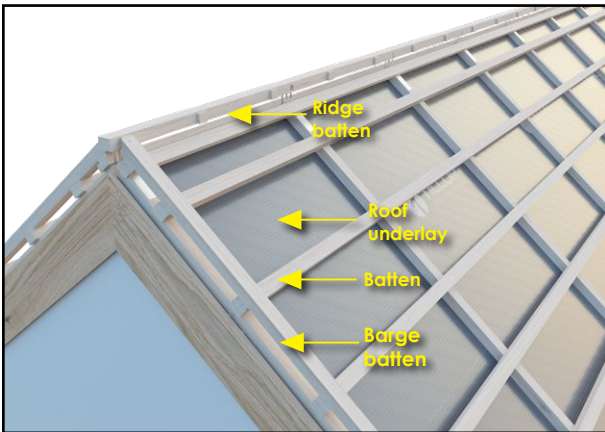

Figure 32.



Figure 33.



Figure 34.

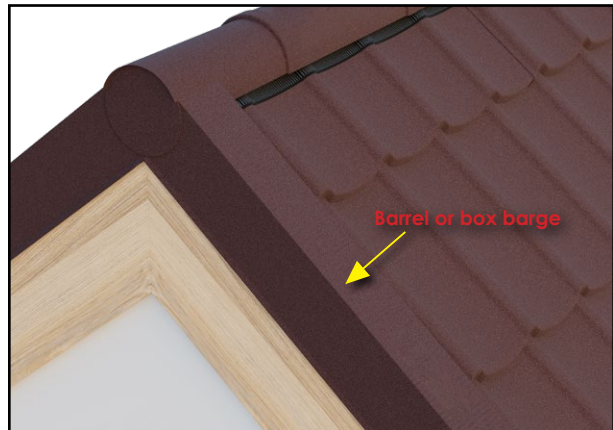

Figure 35.

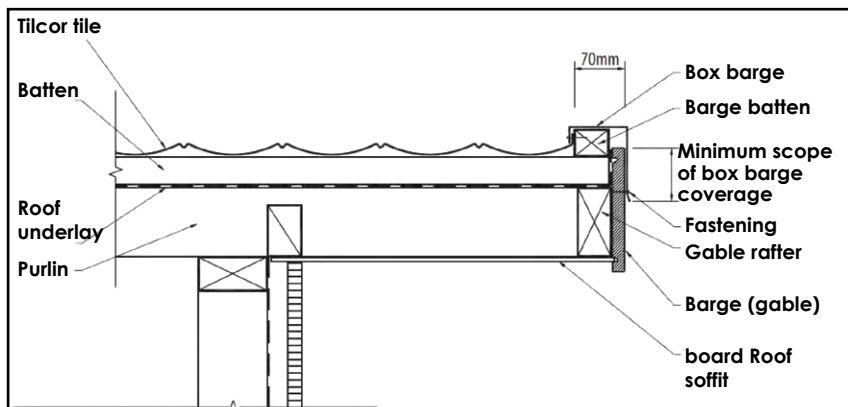

Figure 36.

9. INSTALLATION OF BARRELS AT THE RIDGE AND HIP

At the roof hip, starting from the eaves, put in the first barrel over turned up tile edges running from the sides. Install the other barrels gradually upwards, taking care to maintain the straight line of the hip. Each barrel should be fixed to the batten near the lap. The last hip barrel next to the eaves should be closed with the round barrel end.

At the ridge, the first barrel is placed over tile edges turned up by 40 mm so that they adjoin the internal part of the barrel. Install further barrels so that they are aligned to one another.

Install hip and ridge battens using metal batten supports to ensure the right ventilation. At a juncture of two hips with ridge, we recommend using Y-hips made of HIPS polystyrene.



Figure 37.



Figure 38.



Figure 39.

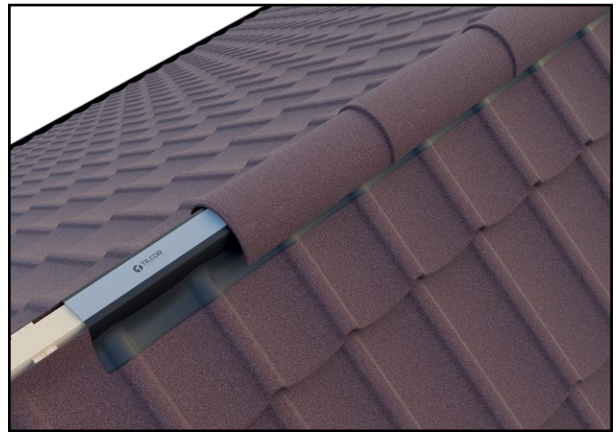

Figure 40.

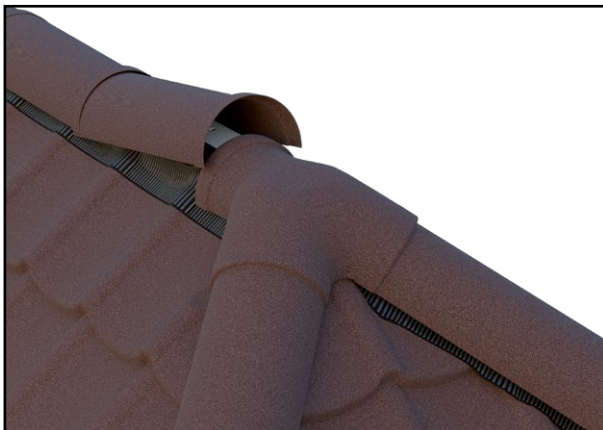

Figure 41.



Figure 42.

10. ROOF WINDOW INSTALLATION

The way that the roof escape window is finally installed depends on its dimensions and the applied sealing flange. The decision to use any pieces is taken by the roofer.

The row of panels under the roof window is fixed from above, vertically to the batten. The roof window should be located vertically so that the row of panels running over it is complete, without any cut tiles along the window length. On the other hand, the row of panels under the roof window may include some cut tiles, which will be hidden under the apron of the window. When installing a horizontally-aligned pair of windows, add an extra supporting counter-batten in the upper part of the window flange. To that counter-batten, Tilcor tiles are installed, fixed from above.



Figure 43.



Figure 44.



Figure 45.

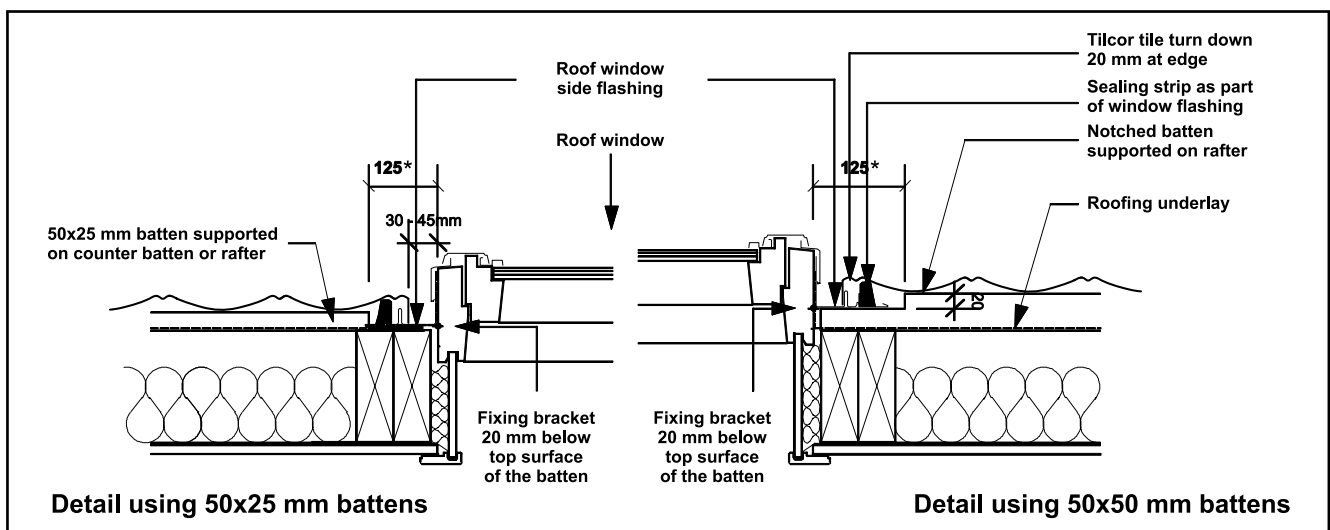

Figure 46.

11. ROOF VENTILATION, EXTRACTOR AND SANITARY VENTS

Every roof surface with a loft should be correctly ventilated from eaves to ridge. The minimum ventilation cross-section required by the DIN 4108 standard is 200 cm² per running meter.

Such ventilation space near the eaves is ensured for a counter-batten which is 1 inch, i.e. 25 mm, high. On the other hand, under the ridge, we recommend using Shake LV75 roof space vents installed in the second row below the ridge, every second space between the rafters. In Polish conditions, this means a distance of approx. 170-200 cm of the roof surface length.

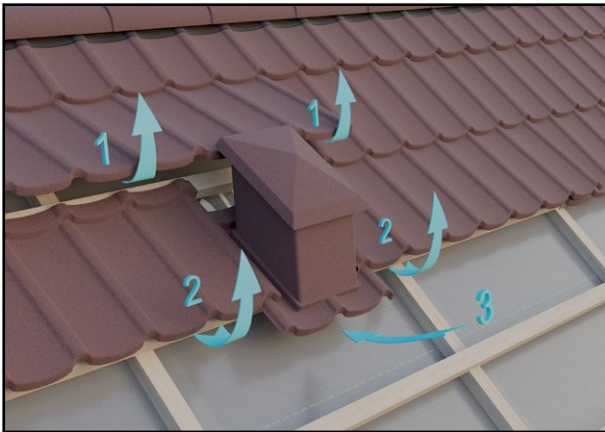

Figure 47.

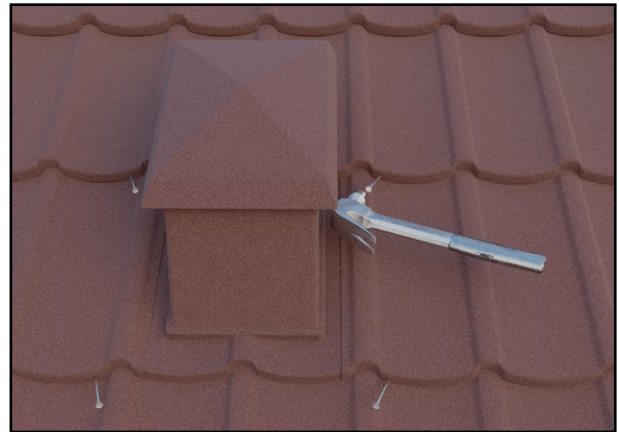

Figure 48.



Figure 49.

Tilcor ventilation tiles are made of highly impact resistant HIPS polystyrene and should not be fixed directly with nails. The right installation requires putting on tile panels from above and on both sides to the edges of the ventilation tile. This is shown in the drawings above.

The position at which the ventilation tile is to be installed follows from finding the shortest simple route from the ventilated room to the roof surface. To ensure the best gravitational draft, the spiral pipe should not be bent vertically more than once or twice.



Figure 50.



12. VALLEY INSTALLATION

1. Before a metal valley without stone chips is installed, scaffolding must be put up to serve as support for the installation. First, valley boards are to be installed along the valley rafter. The boards are installed directly on rafters. The width of a valley on one side should be at least 150 mm. A valley in the system of stone-coated tile is the so called "embedded" valley, or lying at the level of the lower edge of a batten. A valley should be formed so that it diverts without any obstacles water and wet snow from the roof surface to the gutter.

A valley should be cut at the bottom near the eaves to be aligned with the eaves row of stone-coated panels. Its end should be located directly over the gutter.

Between the valley and valley boards, there should be underlay of possibly two layers of roof underlay.

2. If valleys must be joined, please keep a minimum 150 mm overlap. Never perforate the valley gutter! A valley is installed with clamps to timber battens on the sides.

The opening of the valley should be at least 80 mm, and in mountainous areas 100 mm.

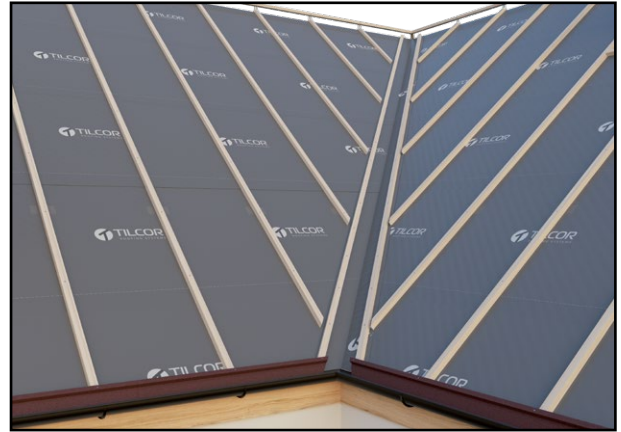

Figure 51.



Figure 52.



Figure 53.



Figure 54.

12. VALLEY INSTALLATION continued

3. When joining two valleys, e.g. of a dormer, please remember first of all about weather tightness. Both valleys should be cut and joined with moisture- and frost-resistant roofing glue. Flashings may be joined by tongue and groove fitting. Always be conscious of the aesthetic appearance of the valley installation.

Tile measuring, cutting and bending for valleys is carried out as for barge boards or ridges, except that the bends are downwards to approx. 40 mm. To set the cutting and bending lines appropriately, remember to add 50 mm to the bending line at the upper part of the panel and 40 mm to the bending line at the lower part (nose) of the tile.

The panels must be bent downwards immediately beside the valley edge. Do not cut the panel edges but straighten (flatten) them. Tilcor tiles should be bent down to approx. 5mm from the valley floor.

Panels joining the valley are fixed to the batten with nails driven in the front of the panel, as close as possible to the valley edge.

To cut and bend panels at the valley, use the guillotine and the bender.

Valley boards must be dry and separated from the valley by a double layer of underlay. To seal the valley further, it is possible to use a universal wedge-shaped sealant made of sponge. It is stuck on both sides of the valley so that it is invisible after the panels are installed.



Figure 55.



Figure 56.

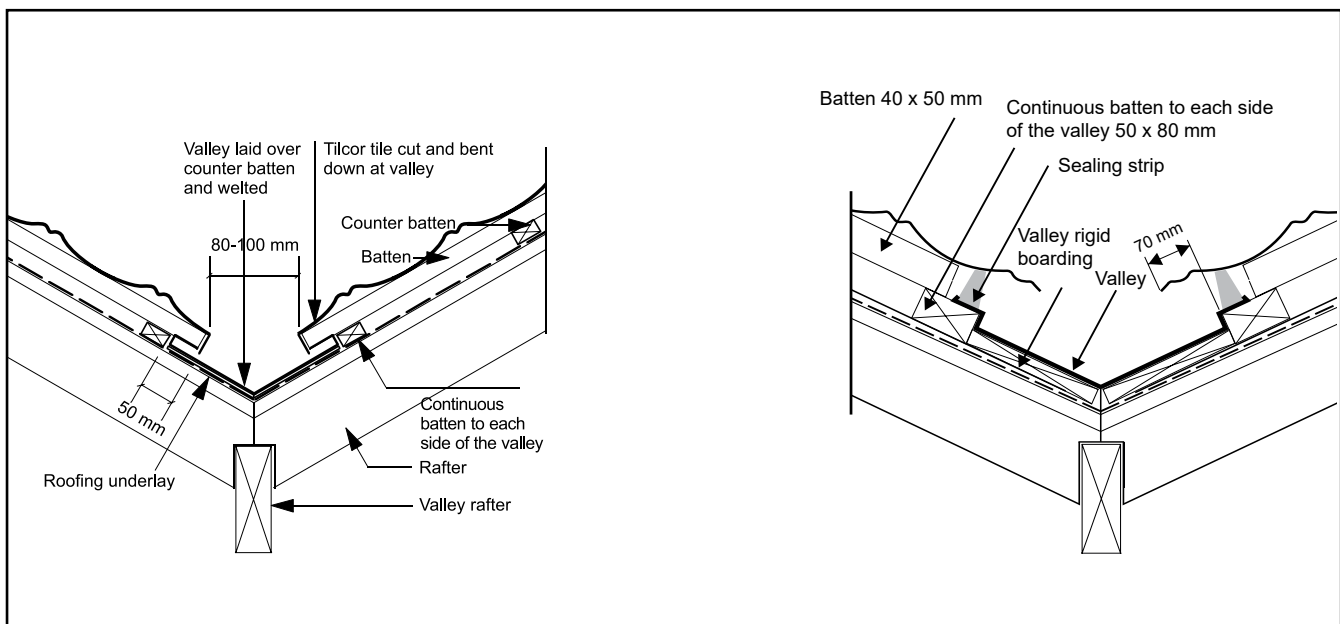

Figure 57.

13. SIDE WALL FLASHING

Panel ends in all rows must be turned up by approx. 50 mm and go under the side flashing. It is very important to bend the panel before cutting it. This makes it possible to avoid tile deformations. Wall flashing should be made in such a way as to ensure that water is directed down the roof surface into the gutter and to prevent leakages on the wall. Never install bent panels with edges directly to the wall. An independent masking flashing made of system side flashing or flat sheet will be fixed to the wall. Remember also to turn the roof underlay up to the flashed wall.

A similar flashing is provided when installing panels to the front wall, e.g. of a dormer built in the center of the roof surface.

We recommend making any sidewall, front wall, chimney etc. flashings before laying the roof surface proper. This way it is possible to avoid unnecessary folds and movement on the roof.

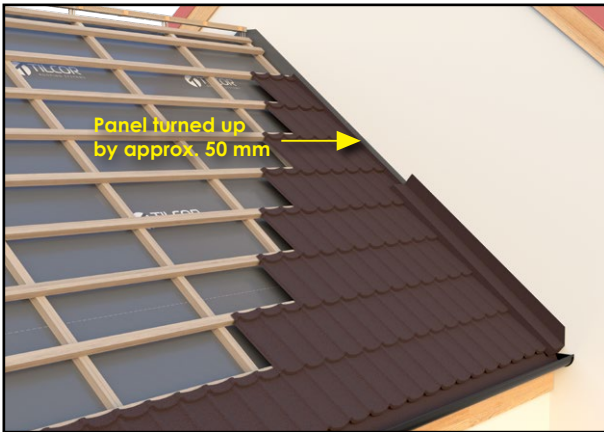

Figure 58.



Figure 59.

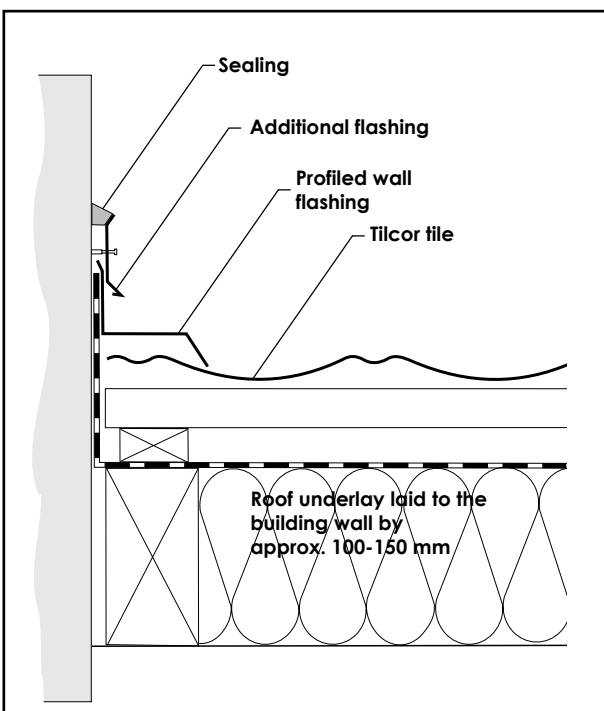

Figure 60.

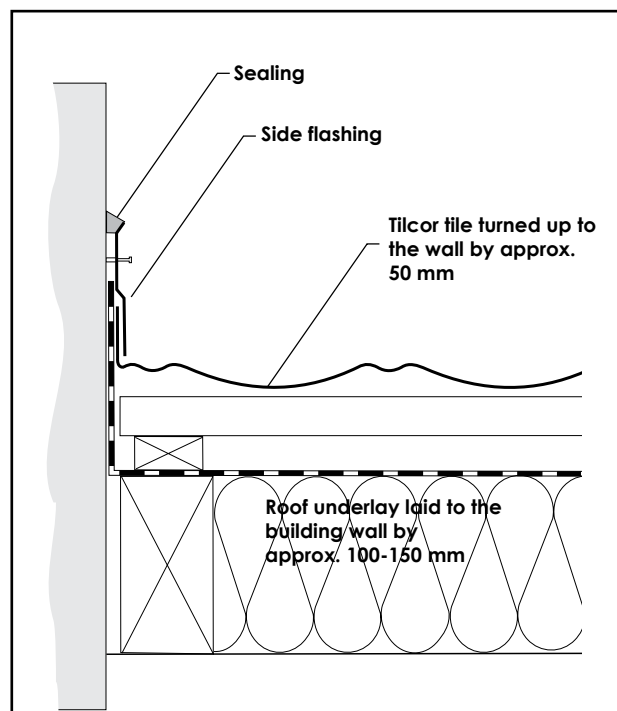

Figure 61.

14. CHIMNEY FLASHING

All the elements of the chimney flashing should be installed so as to ensure weather tightness. Ensure that the flashing made behind the chimney make it possible to divert water and snow to the sides without any obstacles. Sometimes it makes sense to form buffer flashings. Chimney flashings are particularly important. Their defective workmanship is the most common cause of water leakages under the roof surface. Panels and roof underlay must be bent to the side walls of the chimney. To make it easier, roof underlay may be fixed to the chimney with adhesive tape. Panels cannot be permanently joined with the chimney. Only the side flashing around the chimney will be fixed permanently to the chimney, covering the bent edges of panels. Its upper part should be also sealed with roofing putty resistant to moisture and temperature. Behind the chimney, an extra batten may be installed on which flashing will be placed. This will make it easier for water to flow out of that part. Side flashings of the chimney should be joined by tongue and groove fitting.



Figure 62.

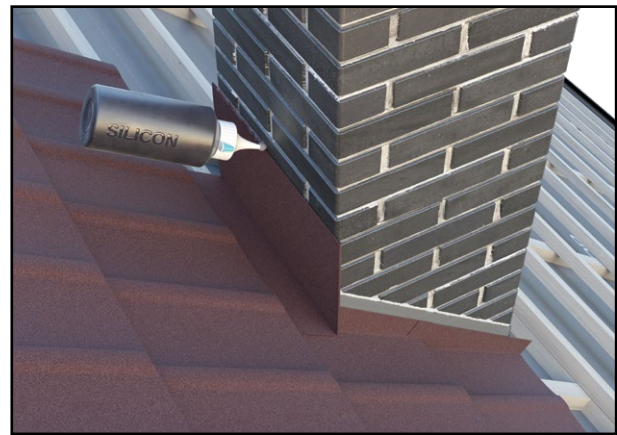

Figure 63.



Figure 64.



Figure 65.



Figure 66.

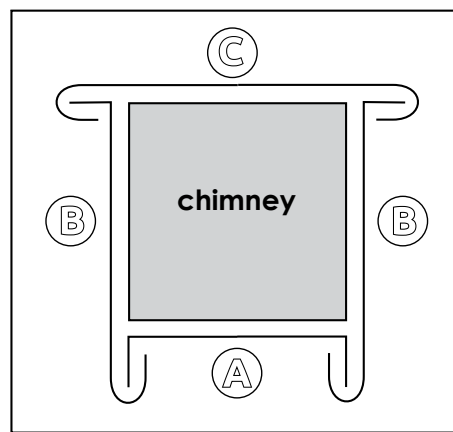

Figure 67.

15. MANSARD ROOF INCLUDING A CHANGE OF ROOF PITCH

The installation should proceed as shown in the figure. A timber batten is placed at the point where the roof line changes pitch. In situations where you have a pitch change in the middle of a panel, the bending line should be marked lengthwise. We should, however, make an effort to distribute the battens of a mansard roof so as to avoid the lengthwise bending of panels.

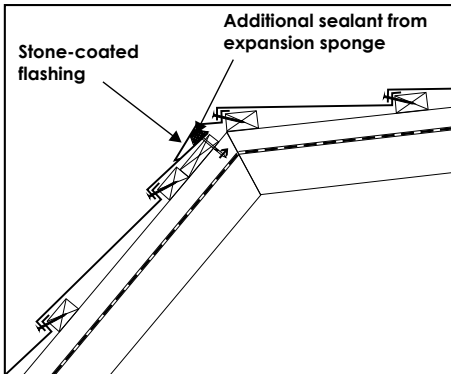

Figure 68.

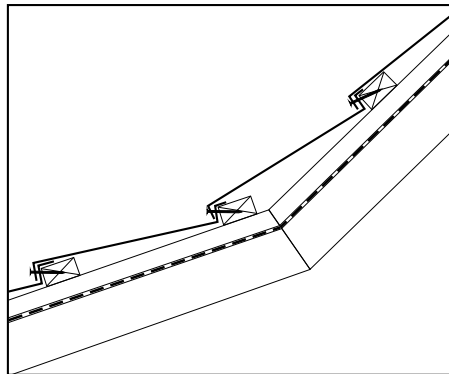

Figure 69.

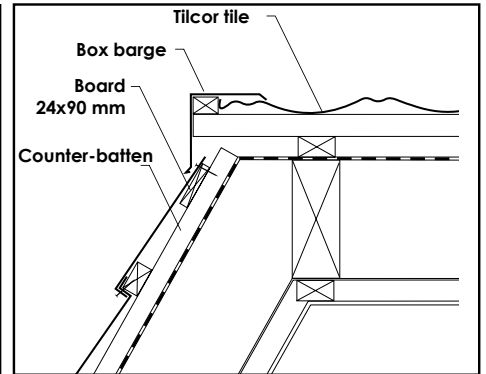

Figure 70.

16. RE-ROOFING

Tilcor stone-coated tiles make it possible to be installed directly on an old roof without it being necessary to dismantle it. The necessary condition for such an application is to check the strength of the old construction, especially the stability of rafters. It is also necessary to straighten the roof surface. It is possible to do it by counter-battens and battens and the so called spacer battens.

In principle, the installation on an old roof is possible in the case of asphalt shingles, wood shake shingles, low-profile roofing sheet. Remember to use counter-battens installed on the old roof so as to ensure ventilation space between the old and the new roof.

At the eaves, install starter flashing (gutter strip) for esthetic appearance and air inflow to ensure ventilation. At the ridge and hips of the roof, ordinary system solutions are used in the form of round barrels or angle trims.

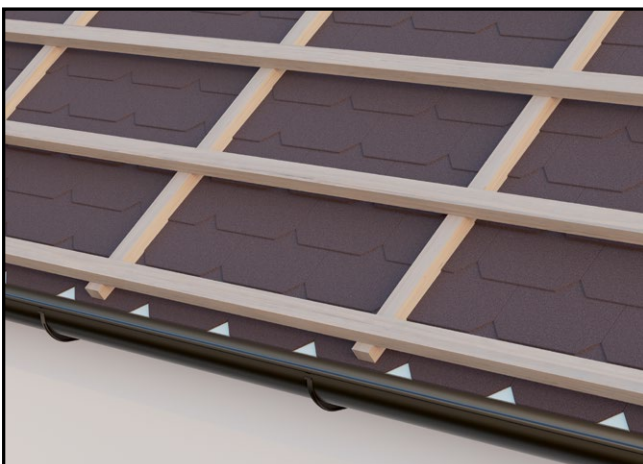

Figure 71.

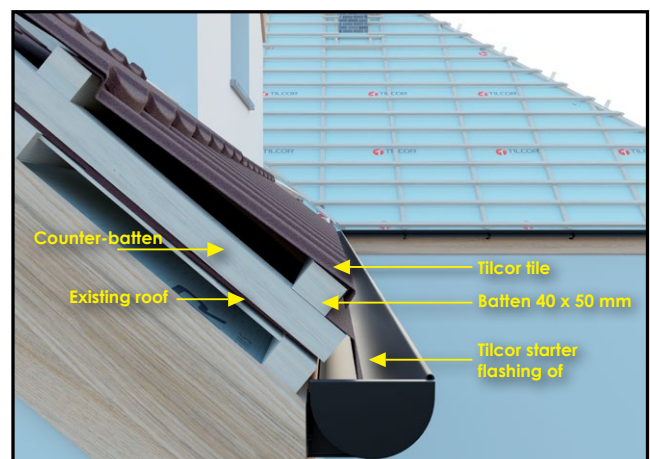

Figure 72.

17. SOLAR HOLDER

The size of the rails attached to the roof hooks and carrying the PV module is dependent on local conditions such as snow and wind loads, shape and height of the building, national and local building regulations and standards, and environmental regulations.



Figure 73.

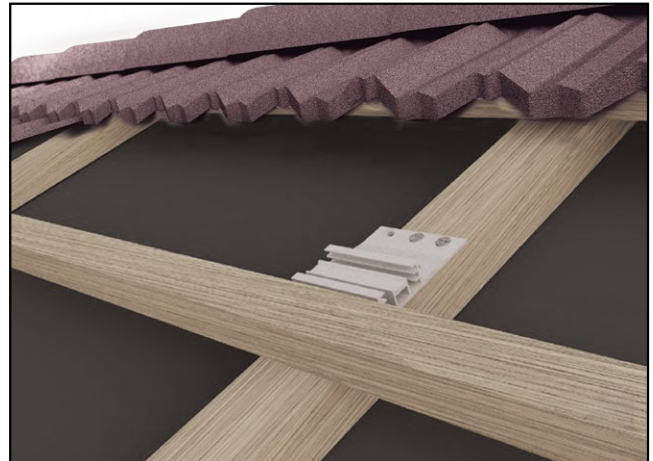

Figure 74.



Figure 75.

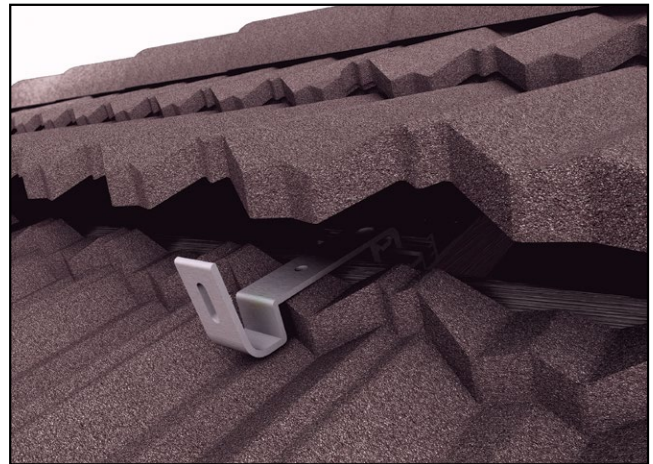

Figure 76.



Figure 77.



Lightweight:
Tilcor Steel Roof Tiles are a lightweight interlocking roof system, with uncompromising strength.



Sustainability:
Engineered from high grade Aluminium-Zinc coated steel, a Tilcor roof is one of the most recyclable and sustainable building products in the world.



Protection from the Sun:
Tilcor Roof Tiles incorporate "state of the art" acrylic coating technology and have been tested all over the world .



Weather Security Warranty:
Full 25 years weatherproof warranty plus a diminishing pro-rata weatherproof warranty for the subsequent 25 years.



Marine Environments:
Tilcor roof tiles are suitable for all marine environments and are backed by our warranty.

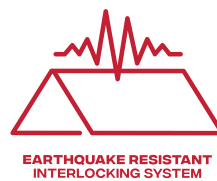

Earthquake:
Tilcor Steel Roof Tiles are an interlocking roof system. The tiles are individually fixed and are less likely to fall through the ceiling during an earthquake.



Hail Resistance:
Tilcor Steel Roof Tiles achieve the highest UL 2218 rating for hail impact resistance in the United States.



Over 75 years roofing Experience:
IKO's growth has come from ownership, accountability, knowledge, research and hard work.



High Wind Resistance:
Tilcor Steel Roof Tiles are engineered to withstand high wind uplift forces. Horizontal fastening and interlocking profiles makes Tilcor roofs wind resistant even in extreme weather.